

## Modular UPS 25~600kVA

- All Hot-swappable Design
- Power Factor 1 (kVA=kW)
- High Efficiency 96%
- Standard Parallel Function
- Fault Trace Management



## Features and Advantages

### High Reliability:

- Wide input voltage range +/- 20% (up to -40% at reduced load)
- Hot-swappable function ensures uninterrupted operations during maintenance
- Dual system control card prevents single point of failure
- Intelligent fan control and redundant design for energy saving
- Parallel expansion up to four systems without requiring additional hardware

### High Performance:

- High efficiency in online mode (>96%) reduces heat dissipation and limits power consumption costs
- THDi ≤ 3% and input power factor 0.99 reduce the pollution to grid and reduce upstream investment costs
- Full rated power (kVA=kW) to maximize power availability
- Efficiency > 99% in ECO mode gives significant cost reduction
- Advanced power module sleep mode, prolong the service life of power module
- Allow 100% three phase unbalance load
- Frequency converter function (60Hz to 50Hz or 50Hz to 60Hz)
- Loop test function without load enables on-site commission
- Small footprint, 300kW only covers 0.5m<sup>2</sup>

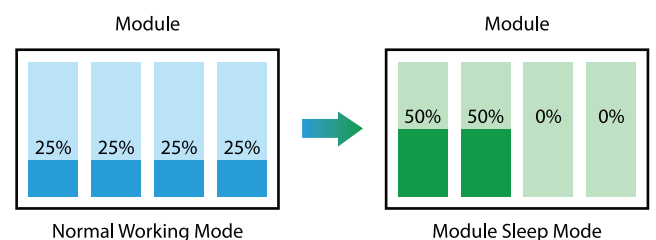
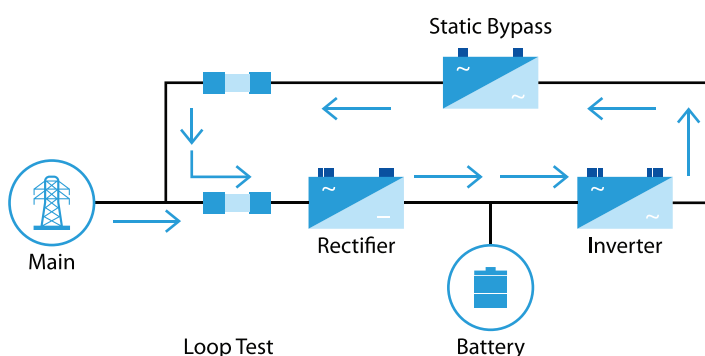

## Smart Management:

- Fault Trace Management (FTM) for convenient failure analysis(80ms waveform record)
- 7-inch HMI for clear parameter setting and status overview
- Intelligent battery charging system, prolong the service life of batteries
- Flexible battery management, 30-46 pcs batteries per group
- Common battery bank sharing in parallel system

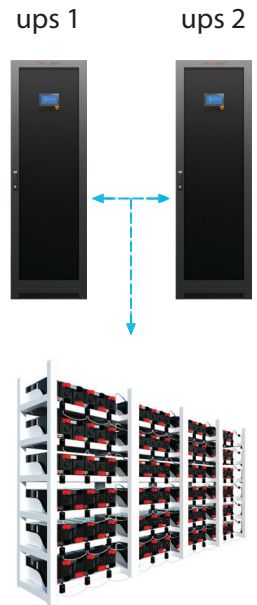
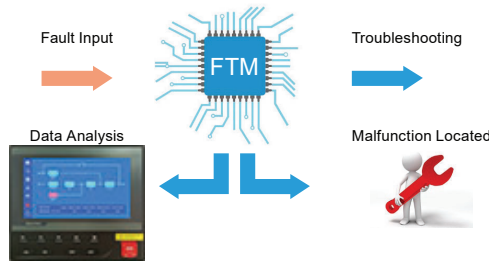

## More Options

### Battery Monitoring Solutions:

- Advanced battery monitoring per block voltage, Impedance, and temperature.

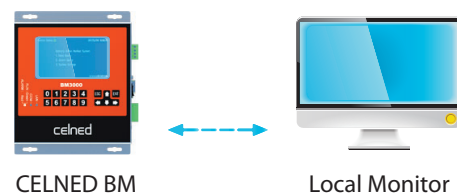

### Flexible Network Management:

- Optional internal SNMP adapter
- Customer interface software

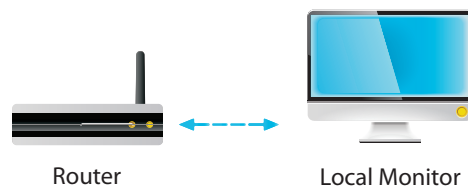

### Intelligent management software

- Smart status diagnosis
- Abnormal status real time alarm
- Event logs recording
- Parameters real time monitoring

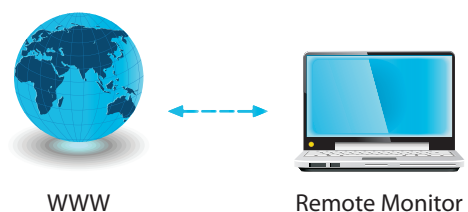

MODEL	X-PND 125	X-PND 200	X-PND 300	X-PND 400	X-PND 500	X-PND 600	
Power Module	XPD - 25	XPD - 50					
<b>Input</b>							
Rated Voltage (Vac)	380/400/415						
Voltage Range (Vac)	L : L 138~485						
Input Wiring	3Ph+N+PE						
Input Frequency (Hz)	40-70						
Bypass Voltage Range (Vac)	-15% (-20%/-30% optional) ~+15%(+10% /+20% optional)						
Power Factor	≥0.99						
THDi	<5% (nolinear, full load)						
Phase	3Φ4W+PE						
Battery (Vdc)	±192 (±180 ~ ±276 settable)			±240 (±180 ~ ±276 settable)			
Charging Current (A)	N× 10 Maximum (N = the number of power module)						
<b>Output</b>							
Capacity (kVA)	125	200	300	400	500	600	
Power Factor	1						
Phase	3Φ4W+PE						
Waveform	sine wave						
Voltage (Vac)	L-L:380,400,415 ±1%						
Frequency (Hz)	50/60± 0.2% (battery mode)						
Three Phase Difference	≤1 °						
THDv	≤1% (linear load, full load); ≤4% (nolinear load, full load)						
Static Bypass Transfer Time	0						
System Efficiency	96%						
Parallel Mode	Advanced no-master-slave parallel technology, N+1 redundancy						
Overload Capacity	106-110% load for 60 minutes, 111%-130% load for 10 minutes, 131%-150% load for 1 minute, 151%~200% load for 200ms.						
<b>Others</b>							
Approvals	CE (EN62040-2, IEC62040-1)						
Operating Temperature (°C)	0~40						
Storage Temperature (°C)	-40~70						
Relative Humidity	0~95%, no condensation						
Communication Function	RS485, RS232, dry contact (SNMP optional)						
Noise (dB)	<65	<70					
Power Module (kVA)	25	50					
Power Module Dimension (W×D×H)(mm)	500×700×130						
Dimension(W×D×H)(mm)	600×860×2000			1200×860×2000			
Weight (kg)	Cabinet	162	224	236	427		
	Bypass Module	20	23	27	27	31	31
	Power Module	32	33				

**TECNED**

Tjalke de Boerstrjitte 12, 8561 EL, Balk, The Netherlands

+31-514-820222, Enquiries: sales@tecned.com, Support: service@tecned.com